

# ACCU ELECTRIC MOTORS INC

USA: (888) 932-9183

CANADA: (905) 829-2505

- ✓ Over 100 years cumulative experience
- ✓ 24 hour rush turnaround / technical support service
- ✓ Established in 1993



The leading independent repairer of servo motors and drives in North America.

Visit us on the web:

[www.servo-repair.com](http://www.servo-repair.com)

[www.servorepair.ca](http://www.servorepair.ca)

[www.ferrocontrol.com](http://www.ferrocontrol.com)

[www.sandvikrepair.com](http://www.sandvikrepair.com)

[www.accuelectric.com](http://www.accuelectric.com)

**Scroll down to view your document!**

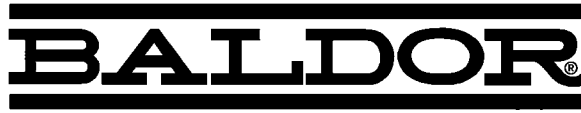
For 24/7 repair services :

USA: 1 (888) 932 - 9183

Canada: 1 (905) 829 -2505

Emergency After hours: 1 (416) 624 0386

Servicing USA and Canada



# **Brushless Servo Motors**

**Installation and Operating Manual**



# Table of Contents

---

## Section 1

<b>General Information</b> .....	1-1
Overview .....	1-1
Limited Warranty .....	1-1
Safety Notice .....	1-2

## Section 2

<b>Installation</b> .....	2-1
Overview .....	2-2
Location .....	2-2
Mounting .....	2-2
Alignment .....	2-2
Receiving .....	2-3
Storage .....	2-3
Unpacking .....	2-3
Handling .....	2-3
Repairs .....	2-3
Prevent Electrical Noise .....	2-3
Shaft Loads .....	2-4
Life Determination .....	2-6
Speed and Torque .....	2-8
Holding Brake .....	2-8
Electrical Connections .....	2-10
Overview .....	2-10
Motor Lead Termination .....	2-10
Feedback Termination .....	2-12
Feedback Devices .....	2-13
Brushless Servo Motor Identification .....	2-15



# Section 1

## General Information

---

**Overview** This manual contains general procedures that apply to Baldor Motor products. Be sure to read and understand the Safety Notice statements in this manual. For your protection, do not install, operate or attempt to perform maintenance procedures until you understand the Warning and Caution statements. A Warning statement indicates a possible unsafe condition that can cause harm to personnel. A Caution statement indicates a condition that can cause damage to equipment.

**Important:** **This instruction manual is not intended to include a comprehensive listing of all details for all procedures required for installation, operation and maintenance. This manual describes general guidelines that apply to most of the motor products shipped by Baldor. If you have a question about a procedure or are uncertain about any detail, Do Not Proceed. Please contact your Baldor distributor for more information or clarification.**

Before you install, operate or perform maintenance, become familiar with the following:

- NEMA Publication ICS16, Motion/Position Control Motors; Controls; and Feedback Devices.
- The National Electrical Code
- Local codes and Practices

### **Limited Warranty**

1. Baldor Electric motors are warranted for a period of one (1) year, from date of shipment from the factory or factory warehouse against defects in material and workmanship. To allow for stocking and/or fabrication period and to provide one year of actual service, the warranty period is extended for an additional period of six (6) months for a total of eighteen (18) months from the original date of shipment from the factory or factory warehouse stock. In no case will the warranty period be extended for a longer period. Baldor extends this limited warranty to each buyer of the electric motor for the purpose of resale and to the original purchaser for use.
2. Baldor will, at its option repair or replace a motor which fails due to defects in material or workmanship during the warranty period if:
  - a. the purchaser presents the defective motor at or ships it prepaid to, the Baldor plant in Fort Smith, Arkansas or one of the Baldor Authorized Service Centers and
  - b. the purchaser gives written notification concerning the motor and the claimed defect including the date purchased, the task performed by the Baldor motor and the problem encountered.
3. Baldor will not pay the cost of removal of any electric motor from any equipment, the cost of delivery to Fort Smith, Arkansas or a Baldor Authorized Service Center, or the cost of any incidental or consequential damages resulting from the claimed defects. (Some states do not allow the exclusion or limitation of incidental or consequential damages, so the above exclusion may not apply to you.) Any implied warranty given by laws shall be limited to the duration of the warranty period hereunder. (Some states do not allow limitations on how long an implied warranty lasts, so the above limitation may not apply to you.)

- 
4. Baldor Authorized Service Centers, when convinced to their satisfaction that a Baldor motor developed defects in material or workmanship within the warranty period, are authorized to proceed with the required repairs to fulfill Baldor's warranty when the cost of such repairs to be paid by Baldor does not exceed Baldor's warranty repair allowance. Baldor will not pay overtime premium repair charges without prior written authorization.
  5. The cost of warranty repairs made by centers other than Baldor Authorized Service Centers **WILL NOT** be paid unless first authorized in writing by Baldor.
  6. Claims by a purchaser that a motor is defective even when a failure results within one hour after being placed into service are not always justified. Therefore, Baldor Authorized Service Centers must determine from the condition of the motor as delivered to the center whether or not the motor is defective. If in the opinion of a Baldor Authorized Service Center, a motor did not fail as a result of defects in material or workmanship, the center is to proceed with repairs only if the purchaser agrees to pay for such repairs. If the decision is in dispute, the purchaser should still pay for the repairs and submit the paid invoice and the Authorized Service Center's signed service report to Baldor for further consideration.
  7. This warranty gives you specific legal rights, and you may also have other rights which vary from state to state.

**Safety Notice:** This equipment contains high voltage! Electrical shock can cause serious or fatal injury. Only qualified personnel should attempt installation, operation and maintenance of electrical equipment.

Be sure that you are completely familiar with NEMA publications ICS16 and MG-2, safety standards for construction and guide for selection, installation and use of electric motors and generators, the National Electrical Code and local codes and practices. Unsafe installation or use can cause conditions that lead to serious or fatal injury. Only qualified personnel should attempt the installation, operation and maintenance of this equipment.

**WARNING: Do not use these motors in the presence of flammable or combustible vapors or dust. These motors are not designed for atmospheric conditions that require explosion proof construction.**

**WARNING: Do not touch electrical connections before you first ensure that power has been disconnected. Electrical shock can cause serious or fatal injury. Only qualified personnel should attempt the installation, operation and maintenance of this equipment.**

**WARNING: Be sure the system is properly grounded before applying power. Do not apply power before you ensure that all grounding instructions have been followed. Electrical shock can cause serious or fatal injury. National Electrical Code and Local codes must be carefully followed.**

**WARNING: Avoid extended exposure to machinery with high noise levels. Be sure to wear ear protective devices to reduce harmful effects to your hearing.**

- 
- WARNING:** The holding brake alone does not guaranty personnel safety. Use structural measures such as protective fences or a second brake to secure personnel safety.
- WARNING:** This equipment may be connected to other machinery that has rotating parts or parts that are driven by this equipment. Improper use can cause serious or fatal injury. Only qualified personnel should attempt to install operate or maintain this equipment.
- WARNING:** Do not by-pass or disable protective devices or safety guards. Safety features are designed to prevent damage to personnel or equipment. These devices can only provide protection if they remain operative.
- WARNING:** Avoid the use of automatic reset devices if the automatic restarting of equipment can be hazardous to personnel or equipment.
- WARNING:** Be sure the load is properly coupled to the motor shaft before applying power. The shaft key must be fully captive by the load device. Improper coupling can cause harm to personnel or equipment if the load decouples from the shaft during operation.
- WARNING:** Use proper care and procedures that are safe during handling, lifting, installing, operating and maintaining operations. Improper methods may cause muscle strain or other harm.
- WARNING:** Before performing any motor maintenance procedure, be sure that the equipment connected to the motor shaft cannot cause shaft rotation. If the load can cause shaft rotation, disconnect the load from the motor shaft before maintenance is performed. Unexpected mechanical rotation of the motor parts can cause injury or motor damage.
- WARNING:** Disconnect all electrical power from the motor windings and accessory devices before disassembly of the motor. Electrical shock can cause serious or fatal injury.
- WARNING:** Ensure all electrical connections are securely made. High voltage may be present and high motor speeds may result from a broken connection.
- WARNING:** Pacemaker Danger – Magnetic and electromagnetic fields in the vicinity of current carrying conductors and permanent magnet motors can result in a serious health hazard to persons with cardiac pacemakers, metal implants and hearing aids.
- WARNING:** Dangerous movements can occur when a motor is improperly connected or a fault occurs. Be careful during start-up, troubleshooting and maintenance procedures to avoid injury.
- WARNING:** Severe burn is possible. The motor winding can reach 155 degrees C during operation. Do not touch motor without protective clothing or allow sufficient time for motor to cool to avoid burns.



---

## **Safety Notice** Continued

- Caution:** To prevent premature equipment failure or damage, only qualified maintenance personnel should perform maintenance.
- Caution:** Do not lift the motor and its driven load by the motor lifting hardware. The motor lifting hardware is adequate for lifting only the motor. Disconnect the load from the motor shaft before moving the motor.
- Caution:** To prevent equipment damage, be sure that the control is fused for the maximum motor rated amps listed on the rating plate.
- Caution:** If a HI POT test (High Potential Insulation test) must be performed, follow the precautions and procedure in NEMA MG-1 and MG-2 standards to avoid equipment damage.
- Caution:** Do not perform dielectric withstand tests on any feedback device or motor control as damage may result.
- Caution:** Motor housings get very hot during normal operation. Do not touch the motor after use until it has had sufficient time to cool. Severe burns may result from touching the motor after use.
- Caution:** Do not use the holding brake to stop motion. This will cause premature brake wear and failure. The brakes are not designed to stop a rotating load. The servo drive inputs should always be used to stop motor shaft rotation.
- Caution:** The AC servo motor is not intended to be connected directly to the AC mains. Do not connect AC Mains directly to BSM AC Servo Motors.

If you have any questions or are uncertain about any statement or procedure, or if you require additional information please contact your Baldor distributor or an Authorized Baldor Service Center.

## Section 2 Installation

---

**Overview** Installation should conform to the National Electrical Code as well as local codes and practices. When other devices are coupled to the motor shaft, be sure to install protective devices to prevent accidents. Some protective devices include, coupling, belt guard, chain guard, shaft covers etc. These protect against accidental contact with moving parts. Machinery that is accessible to personnel should provide further protection in the form of guard rails, screening, warning signs etc.

**Location** The motor should be installed in an area that is protected from direct sunlight, corrosives, harmful gases or liquids, dust, metallic particles, and vibration. Exposure to these can reduce the operating life and degrade performance. Be sure to allow clearance for ventilation and access for cleaning, repair, service and inspections. Ventilation is extremely important. Be sure the area for ventilation is not obstructed. Obstructions will limit the free passage of air. Motors get warm and the heat must be dissipated to prevent damage. These motors are not designed for atmospheric conditions that require explosion proof operation. They must **NOT** be used in the presence of flammable or combustible vapors or dust.

**Mounting** The motor must be securely installed to a rigid foundation or mounting surface to minimize vibration and maintain alignment between the motor and shaft load. Failure to provide a proper mounting surface may cause vibration, misalignment and bearing damage. For mounting dimensions, refer to [http://www.baldor.com/products/servo\\_motors.asp](http://www.baldor.com/products/servo_motors.asp) and provide adequate clearance.

**Alignment** Accurate alignment of the motor with the driven equipment is extremely important.

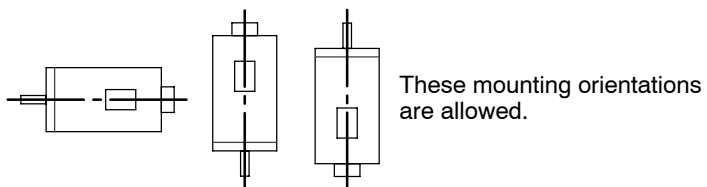
1. **Direct Coupling**

For direct drive, use flexible couplings if possible. Consult the drive or equipment manufacturer for more information. Mechanical vibration and roughness during operation may indicate poor alignment. Use dial indicators to check alignment. The space between coupling hubs should be maintained as recommended by the coupling manufacturer.

2. **End-Play Adjustment**

The axial position of the motor frame with respect to its load is also extremely important. The motor bearings are not designed for excessive external axial thrust loads. Improper adjustment will cause failure.

**Figure 2-1 Mounting Orientation**



---

**Receiving** Each Baldor Electric Motor is thoroughly tested at the factory and carefully packaged for shipment. When you receive your motor, there are several things you should do immediately.

1. Observe the condition of the shipping container and report any damage immediately to the commercial carrier that delivered your motor.
2. Verify that the part number of the motor you received is the same as the part number listed on your purchase order.

**Storage** If the motor is not put into service immediately, the motor must be stored in a clean, dry and warm location. If the parts are not put into service immediately, store them in a clean, dry and warm location. The motor must be protected from moisture and condensation. Storage area should be a dust free environment, maintained  $-25$  degC to  $+85$  degC and less than 90% relative humidity non-condensing.

**Unpacking** Each Baldor motor is packaged for ease of handling and to prevent entry of contaminants.

1. To avoid condensation inside the motor, do not unpack until the motor has reached room temperature. (Room temperature is the temperature of the room in which it will be installed). The packing provides insulation from temperature changes during transportation.
2. When the motor has reached room temperature, remove all protective wrapping material from the motor.

**Handling** Use proper care and procedures that are safe during handling, lifting, installing, operating and maintenance operations. Improper methods may cause muscle strain or other harm.

**Repairs** Baldor will not share any responsibility for damage caused by customer attempt to repair or modify a motor. Consult Baldor for any service.

### **Prevent Electrical Noise**

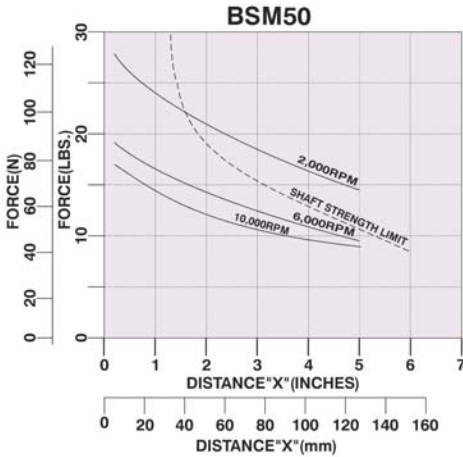
Electro-Magnetic-Interference (EMI), commonly called “electrical noise” may adversely affect motor performance by introducing stray signals. Effective techniques to reduce or prevent EMI include AC power filters, cable shielding, separating signal wires from power wires and good grounding techniques. Effective AC power filtering can be achieved by using properly installed “Isolated AC Power Transformers” or “AC Line Filters”. Other techniques are:

- Install motor cables and signal wires in separate conduits.
- Do not route motor cables and signal wires in parallel. Separate cables by at least 1 foot for every 30 feet of run.
- Cross signal and power wires at 90 degree angles to prevent inductive noise coupling.
- Do not route signal wires over the vent openings of the servo drives.
- Ground all equipment using a single point ground system.
- Keep wires as short as possible.
- Ground both ends of the encoder cable and use twisted pair wires.
- Use shielded motor cables to prevent EMI from other equipment.

**Shaft Loads** The motors can be damaged by excessive shaft loads. This may shorten the motor's service life. The motor warranty is also voided for excessive shaft load related failures.

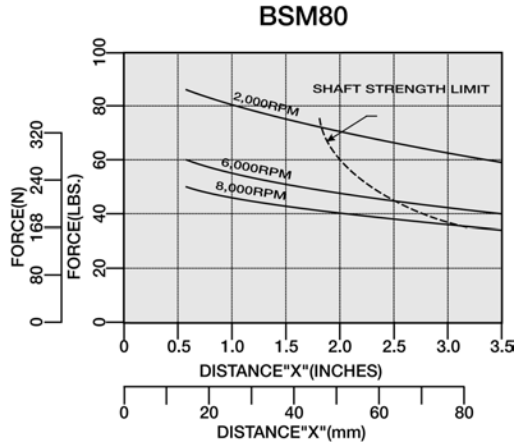
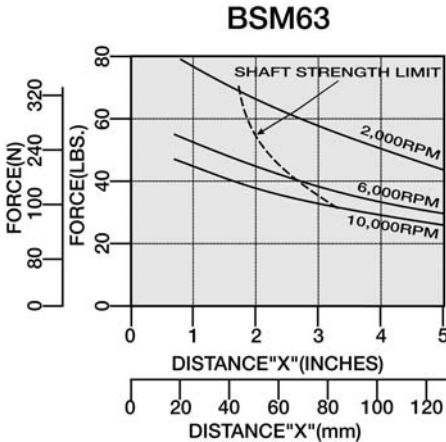
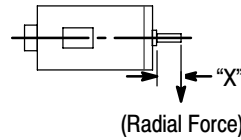
The maximum allowable radial force ( $F_{radial\ max}$ ) depends on the shaft load. It is determined by (distance x force) and the output shaft design (plain shaft or shaft with keyway). When motor shaft has both a radial load and an axial load, axial load rating = 44% of radial load rating listed. Should questions arise contact Motion\_Support@Baldor.com

**Figure 2-2 Radial Load Capacity**



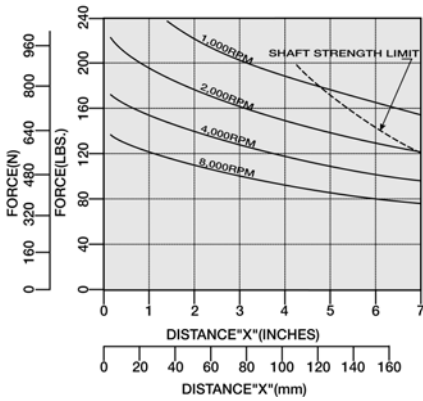
Notes:

- 1) Solid lines are based on  $L_{10} = 20,000$  hours.
- 2) Dashed line is based on  $10^4$  load peaks @ 110% of rated torque.

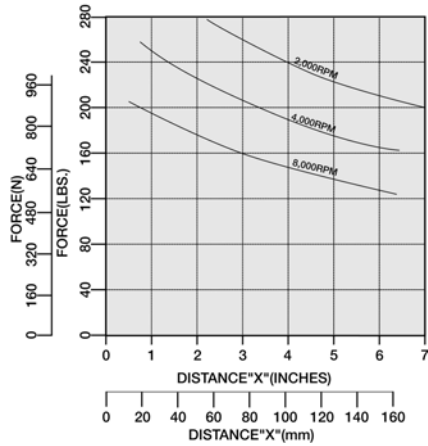


**Figure 2-2 Radial Load Capacity Continued**

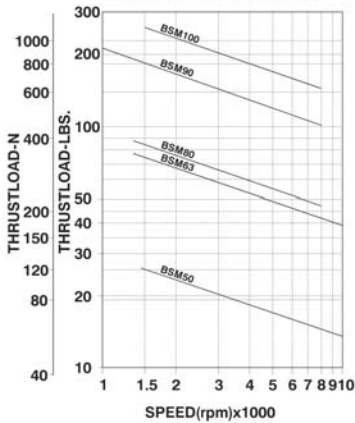
**BSM90**



**BSM100**



**BRUSHLESS SERVO MOTORS  
THRUST LOAD CAPACITIES**



## Life Determination

### How Life is Determined

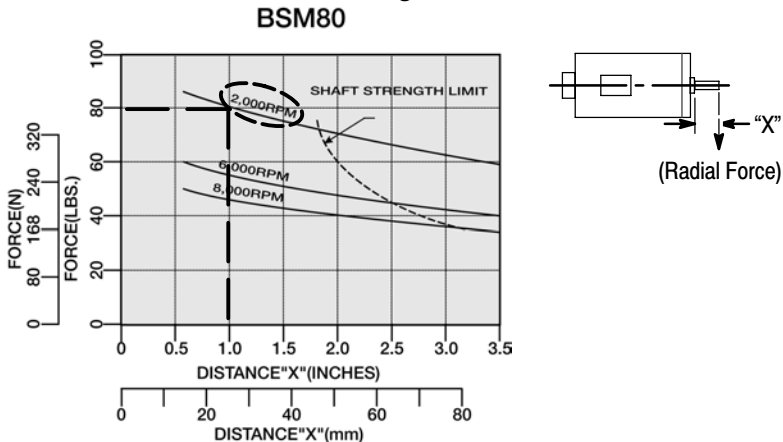
A life estimate is a calculated, statistical expectancy and is defined as the length of time, or the number of revolutions, until fatigue develops. This life depends on many different factors such as loading, speed, lubrication, operating temperature, contamination, plus other environmental factors. It's impossible to predict precisely.

Statistical calculation estimates are based upon  $L_{10}$  life. This is the life that 90 percent of a group, of apparently identical parts, will reach or exceed. Typical bearing radial load capacity curves presented in the literature are based upon bearing  $L_{10}$  life of 20,000 hours.

### Using the Curves

First determine your load (or force), location (or distance) from the bearing the load will be applied, and speed (or RPM). Typical bearing radial load capacity curves presented in the literature are based upon bearing  $L_{10}$  life of 20,000 hours for a BSM80 Motor, (Figure 2-3). Second, plot these points on the curve. For example, a force of 80 lbs (352 N), applied 1 inch (25mm) from the bearing, with a motor speed of 2,000 RPM, would relate to a bearing  $L_{10}$  life estimate of 20,000 hours.

Figure 2-3



Operating 24 hours / day, which is 8500 hours, this would provide a  $L_{10}$  life estimate of: (20,000 hours) (8500 hours/yr)=2.35yrs.

### If Plotted Point Does Not Match your RPM

Many times the point plotted (force and distance), is not specifically on your applications speed curve, so an estimate for life is calculated as follows:

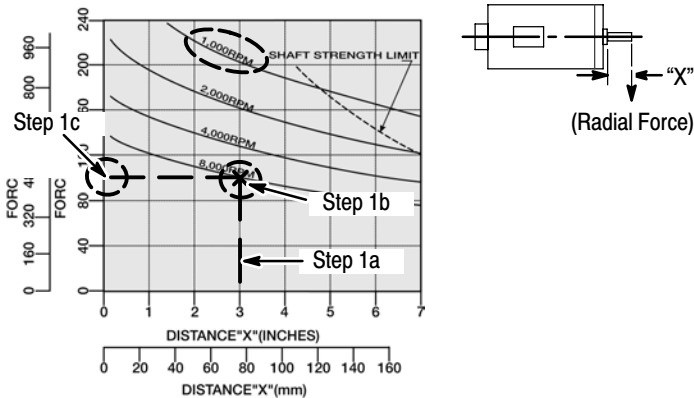
$$L_{10} = \left( \frac{16667}{S} \right) \times \left( \frac{C}{F} \right)^3$$

Where:  $L_{10}$  = 20,000 hours  
 $S$  = RPM  
 $C$  = capacity of system  
 $F$  = Force or Load (lb)

Example: Provide an estimate  $L_{10}$  life for a BSM90 motor with a radial load or force of 130 lbs (570 N) located 3" (76mm) from the bearing. Operating speed is 1000 RPM.

1. Determine the systems capacity – at the distance for our application. To do this, refer to Figure 2-4 and read information from the curve:
  - a. Locate our distance (3") on the X axis.
  - b. Pick a speed (8,000 RPM) and locate the intersect with the 3".
  - c. Read the force (100 lbs) on the Y axis.

**Figure 2-4 BSM90 Load Capacity Curves**  
BSM90



- d. Next, insert these numbers into equation (1) above and solve for capacity "C" (round off for clarity):

$$L_{10} = \left( \frac{16667}{S} \right) \times \left( \frac{C}{F} \right)^3 = \left( \frac{16 \times 10^3}{8 \times 10^3} \right) \times \left( \frac{C}{100} \right)^3$$

$$20,000 = \left( \frac{16667}{8000} \right) \times \left( \frac{C}{100} \right)^3$$

$$C = 2125$$

2. Now that capacity is known, it is possible to estimate  $L_{10}$  with the applications load of 130 lbs (570 N) and 1000 RPM.

$$L_{10} = \left( \frac{16667}{S} \right) \times \left( \frac{C}{F} \right)^3 = \left( \frac{16 \times 10^3}{1 \times 10^3} \right) \times \left( \frac{2125}{130} \right)^3 = 72,795 \text{ hours}$$

This relates to 72,795 hours / 8500 hours/yr = 8.56 years.

## Conclusion

Life is a statistical calculation based upon 90 percent of identical parts reaching or exceeding an estimate. It depends on many different factors and is impossible to predict precisely, however calculations provide a guideline.

## Motor Poles

BSM50/63/80 Series motors are 4 pole (2 pole pair)

BSM90/100 Series motors are 8 pole (4 pole pair)

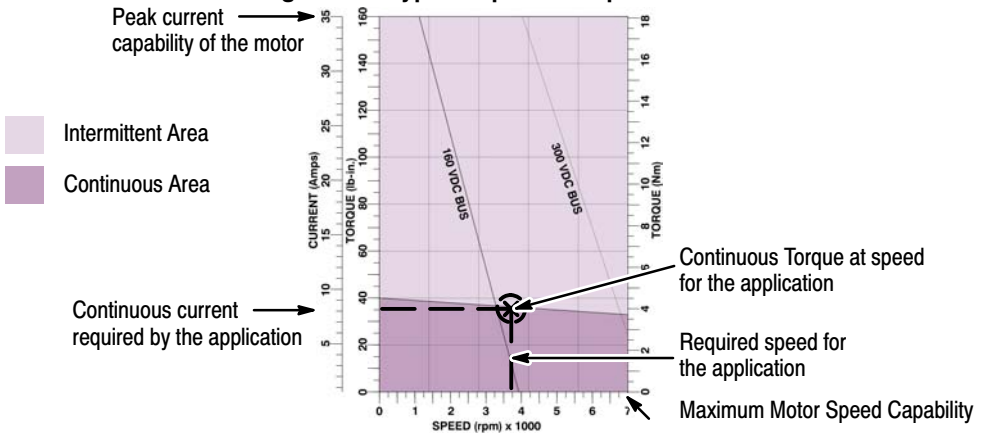
## Speed and Torque

The speed–torque curves for a motor show the safe operating area, speed limit area and intermittent operating area. These curves are used to determine the maximum useable speeds with known torque requirements. If operating within the continuous area, the motor’s thermal limit will not be exceeded. If operated within the intermittent area (extended operation in this area will cause the motor to overheat), the operating time in this area must be limited to prevent overheating.

Brushless servo motors are rated at an ambient of 25 degrees C and a temperature rise of 130 degrees C. For operation at 40 degrees C derate by 6%.

**WARNING: Severe burn is possible. The motor winding can reach 155 degrees C during operation. Do not touch motor without protective clothing or allow sufficient time for motor to cool to avoid burns.**

Figure 2-5 Typical Speed–Torque Curve



## Holding Brake

Holding brakes are offered as options for servo motors. These brakes are designed to hold the motor shaft at 0 RPM (to rated brake holding torque). The purpose of the holding brake is to hold the servo axis when power to the machine is turned off. The holding brake uses the “electric release” principle. Apply 24VDC to the brake causes the brake to release and let the motor shaft rotate. Loss of power causes the brake to hold the motor shaft.

The machine controller controls the holding brake. This ensures correct On and Off switching sequence.

**WARNING: The holding brake alone does not guarantee personnel safety. Use structural measures such as protective fences or a second brake to secure personnel safety.**

**Caution: Do not use the holding brake to stop motion. This will cause premature brake wear and failure. The brakes are not designed to stop a rotating load. The servo drive inputs should always be used to stop motor shaft rotation.**



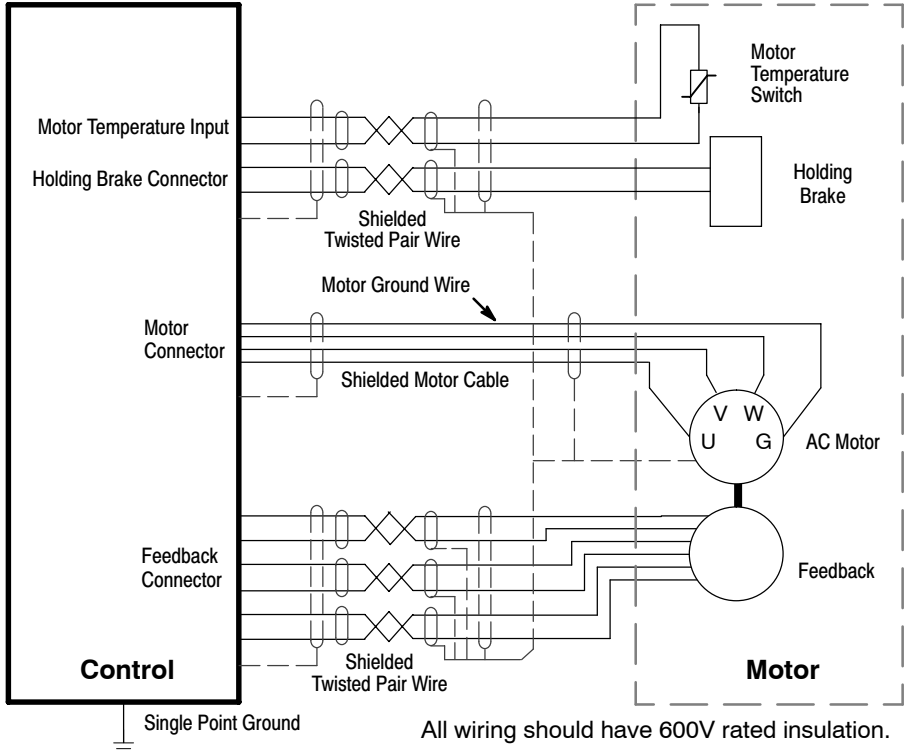
**Table 2-1 Brake Specifications**

Motor Code	Brake Holding Torque (lb-in / N-m)	Watts	Brake Voltage VDC	Brake Current AMPS	Brake Times (msec)	
					Pull-in	Pull-out (with Diode)
BSM50N-1	13/1.4	10.1	24	0.5	18.6	55
BSM50N-2	13/1.4	10.1	24	0.5	18.6	55
BSM50N-3	13/1.4	10.1	24	0.5	18.6	55
BSM63N-1	18/2	11.9	24	0.6	33.5	33.8
BSM63N-2	18/2	11.9	24	0.6	33.5	33.8
BSM63N-3	18/2	11.9	24	0.6	33.5	33.8
BSM80N-1	40/4.5	19.7	24	0.7	34.5	79.3
BSM80N-2	40/4.5	19.7	24	0.7	34.5	79.3
BSM80N-3	40/4.5	19.7	24	0.7	34.5	79.3
BSM90N-1	77/8.7	22.5	24	0.9	64.1	73.6
BSM90N-2	140/15.8	22.5	24	0.9	64.1	73.6
BSM90N-3	140/15.8	22.5	24	0.9	64.1	73.6
BSM100N-1	200/22.5	31.4	24	1.3	83.9	188
BSM100N-2	200/22.5	31.4	24	1.3	83.9	188
BSM100N-3	350/39.5	33.7	24	1.4	157.3	220
BSM100N-4	350/39.5	33.7	24	1.4	157.3	220
BSM80C-1	30/3.3	19.7	24	0.8	34.5	79.3
BSM80C-2	30/3.3	19.7	24	0.8	34.5	79.3
BSM80C-3	30/3.3	19.7	24	0.8	34.5	79.3
BSM90C-1	77/8.7	22.5	24	0.9	64.1	73.6
BSM90C-2	77/8.7	22.5	24	0.9	64.1	73.6
BSM90C-3	77/8.7	22.5	24	0.9	64.1	73.6
BSM100C-1	200/22.5	31.4	24	1.3	83.9	188
BSM100C-2	200/22.5	31.4	24	1.3	83.9	188
BSM100C-3	200/22.5	31.4	24	1.3	83.9	188
BSM100C-4	200/22.5	31.4	24	1.3	83.9	188
BSM100C-5	350/39.5	33.7	24	1.4	157.3	220
BSM100C-6	350/39.5	33.7	24	1.4	157.3	220

## Electrical Connections

**Overview** Figure 2-6 shows typical connections to a control. Note all wiring should be 600volts.

**Figure 2-6 Typical Connections to Motor Control**

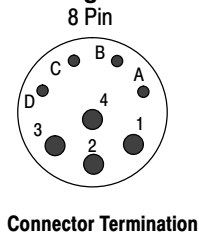


### Motor Lead Termination

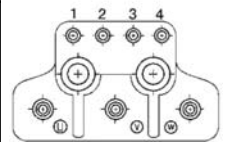
Motor leads are normally terminated using a Connector or Terminal Box (see Figure 2-7) or Flying Leads. When no termination is provided and the motor leads just exit the motor housing, this is called "Flying Leads". For flying leads, refer to the motor packing list to determine the lead configuration.

**Figure 2-7 Motor Termination**

Function	Pin
Thermal Switch	A
Thermal Switch	B
Brake	C
Brake	D
U	1
Ground	2
W	3
V	4



Function	Pin
Thermal Switch	1
Thermal Switch	2
Brake	3
Brake	4
U	U
V	V
W	W
Ground (P.E.)	Screw



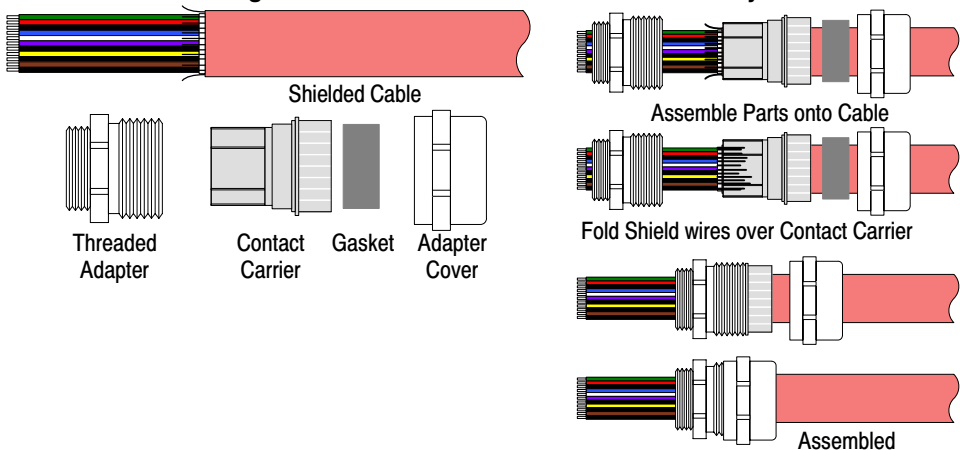
---

## Strain Relief (Mounted at Terminal Box)

The motor cable is terminated at the Terminal Box using a Shielded Strain Relief Connector. Figure 2-8 shows the components.

1. Strip the outer shield from the cable to expose the conductors and shield.
2. Slip the Strain Relief components onto the cable in the order shown.
3. Fold the Shield wires over the end of the Contact Carrier.
4. Slide the Threaded Adapter onto the Contact Carrier until the Carrier is completely inserted into the Adapter.
5. Slide the Gasket into the Contact Carrier.
6. Slide the Adapter Cover onto the Threaded Adapter and Tighten. As it is tightened, it compresses the Gasket against the Cable to form the strain relief and securely hold the cable.
7. The assembly can be inserted into the Terminal Box and secured.

**Figure 2-8 Motor Cable Strain Relief Assembly**

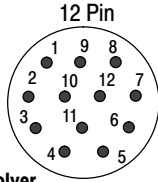


## Feedback Termination

Connections for Feedback cables are different for each type of feedback device. Standard devices are: Resolver, Halls (Hall Effect), Incremental Encoder with Halls, Absolute Encoder, and SSI (Serial Synchronous Interface) encoder. Custom feedback devices are also available. Request a drawing of your feedback device to determine the pin-out and/or wire color codes.

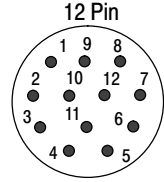
**Figure 2-9 Typical Connections to Feedback Termination**

Function	Pin
R1 REF HI	1
R2 REF LO	2
S1 COS+	3
S3 COS-	4
S2 SINE+	5
S4 SINE-	6
Open	7-12



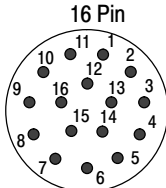
**Resolver**

Function	Pin
Data-	1
SIN A+	2
0V Sensor	3
COS B+	4
Clock-	5
5V Sensor	6
Clock+	7
COS B-	8
+5V	9
D GND	10
SIN A-	11
Data+	12



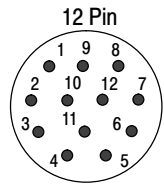
**Absolute Encoder**

Function	Pin
DC +5V	1
Ground	2
Channel A+	3
Channel A-	4
Channel B+	5
Channel B-	6
Channel C+	7
Channel C-	8
Open	9
Channel U+	10
Channel U-	11
Channel V+	12
Channel V-	13
Channel W+	14
Channel W-	15
Open	16



**Encoder with Halls**

Function	Pin
+Vs (5VDC)	1
0V	2
SSI Clock	3
NSSI Clock	4
SSI Data	5
NSSI Data	6



**Serial Synchronous Interface**

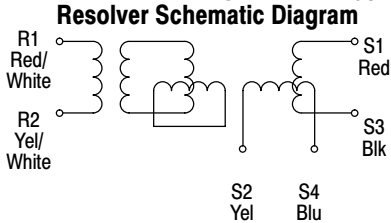
For complete control connections/wiring refer to the following manuals:  
 MN723 – SD23H                      MN7423 – H2 Servo  
 MN1902 – Flex/Flex+Drive<sup>II</sup>    MN1901 – MintDrive<sup>II</sup>  
 MN1919 – MicroFlex

## Feedback Devices

### Resolver

Common feedback devices for Baldor BSM servo motors include Resolver, Encoder, Absolute Encoder, and SSI (Serial Synchronous Interface) encoder. Custom feedback devices are also available. Contact Baldor for more information.

**Figure 2-10 Typical Resolver Feedback Device**

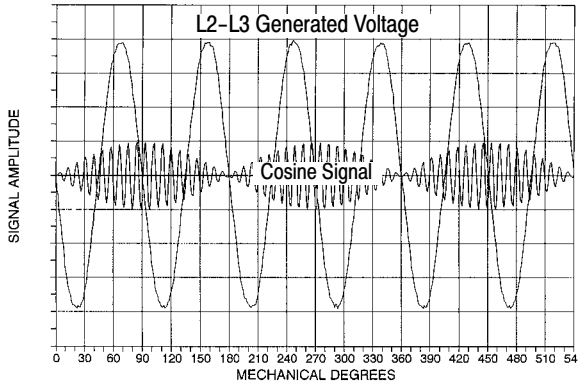


### Resolver Specification

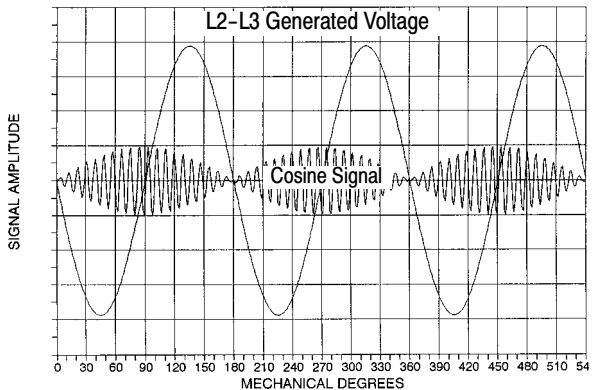
Power Source	AC 10V <sub>RMS</sub> 4.5kHz
Primary Element	Rotor
Electrical Error	±7%
Transformation Ratio	0.5 ±10%
Phase Shift	±8° nominal
Accuracy Spread	12 ARC minutes
Input Impedance	ZRO
Output Impedance	ZSO
DC Resistance	ZSS
	Rotor
	Stator
Dielectric Strength	AC 500 volts, 1 minute 60/50 Hz
Insulation Resistance	100MΩ Minimum DC 500Volts
Weight	0.18kg Maximum
Maximum Operating Speed	10,000 RPM
Operating Temperature Range	-55 °C to +150 °C

L2=Motor lead L2 (V)  
L3=Motor lead L3 (W)

### Waveform 1 8 Pole Motor and 2 Pole Resolver



### Waveform 2 4 Pole Motor and 2 Pole Resolver



**Feedback Devices** Continued

**Encoder**

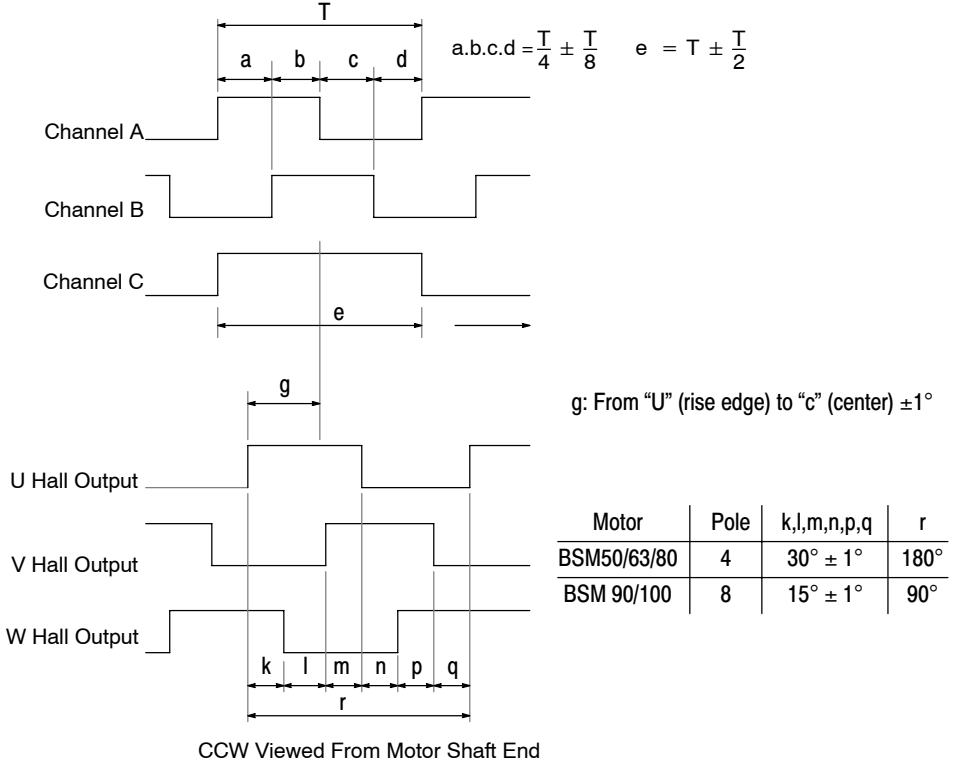
Line Count Depends on unit ordered. Standards are 1000–2500 ppr.  
(Custom resolutions are available.)

Supply Voltage 5VDC

Supply Current 250mA maximum

Output TTL (Line Driver)

**Figure 2-11 Typical Encoder Feedback Device**



## Brushless Servo Motor Identification

□	□	<b>B</b>	<b>S</b>	<b>M</b>	□	□	□	□	□	□	□	□	□	□	□	□	□	□	□	
		Frame					Series				Motor Size		Winding Code							
SS = Stainless Steel		IEC	NEMA		C		N				50		75		etc.					
		50	5N						1											
		63	6N						2											
		80	8N						3											
		90	9N						4											
		100																		
<b>Motor Options</b>																				
<b>Motor &amp; Resolver Connectors</b>																				
<b>Description</b>	<b>Standard (Metric) Threaded Style</b>	<b>Optional (Inch) Quick Connect</b>	<b>Cables</b>	<b>Flying Leads</b>																
Motor (No Shaft Seal)	A	I	E	M																
Motor & Brake	B	J	F	N																
Motor with Shaft Oil Seal	C	K	G	O																
Motor with Brake & Shaft Oil Seal	D	L	H	P																

### Feedback Options

- A = Resolver
- D = Absolute Encoder
- E = Encoder w/Commutation (1000ppr)
- F = Encoder w/Commutation (2500ppr)
- H = Hall effect only
- T = Tach/Hall effect
- Y = Resolver mounting only

### Accessory Options

- Blank = No Option
- M = No Keyway
- N = DIN 42955-R
- O = DIN 42955-R & No Keyway
- P = Optional Motor Connector on BSM 90/100  
(Note: This option available only if current is 20 amps or less).
- Z = Blower 115 VAC

- Notes:
- 1) The standard BSM50/63/80 Series includes feedback device, two threaded connectors (metric style) for feedback and motor terminations, IEC square mounting flange.
  - 2) The standard BSM90/100 Series includes feedback device, one threaded connector (metric style) for feedback, termination of motor lead wires on terminal block, IEC square mounting flange.
  - 3) Motors do not have shaft seal. Motors will meet IP65 if shaft oil seal is added.
  - 4) The standard BSM50 Series has as standard no-keyway.
  - 5) Cables and flying leads are 1 meter long as standard.
  - 6) Contact Baldor for special options
  - 7) Not all options are available on all models.

# Baldor District Offices

## UNITED STATES

ARIZONA  
PHOENIX  
4211 S 43RD PLACE  
PHOENIX, AZ 85040  
PHONE: 602-470-0407  
FAX: 602-470-0464

ARKANSAS  
CLARKSVILLE  
1001 COLLEGE AVE.  
CLARKSVILLE, AR 72830  
PHONE: 479-754-9108  
FAX: 479-754-9205

CALIFORNIA  
LOS ANGELES  
6480 FLOTILLA  
COMMERCE, CA 90040  
PHONE: 323-724-6771  
FAX: 323-721-5899

HAYWARD  
21056 FORBES STREET  
HAYWARD, CA 94545  
PHONE: 510-785-9900  
FAX: 510-785-9910

COLORADO  
DENVER  
2520 W BARBERRY PLACE  
DENVER, CO 80204  
PHONE: 303-623-0127  
FAX: 303-595-3772

CONNECTICUT  
WALLINGFORD  
65 SOUTH TURNPIKE ROAD  
WALLINGFORD, CT 06492  
PHONE: 203-269-1354  
FAX: 203-269-5485

FLORIDA  
TAMPA/PUERTO RICO/  
VIRGIN ISLANDS  
3908 EAST 11TH AVENUE  
TAMPA, FL 33605  
PHONE: 813-249-5078  
FAX: 813-247-2984

GEORGIA  
ATLANTA  
82 TECHNOLOGY DR.  
ALPHARETTA, GA 30005  
PHONE: 770-772-7000  
FAX: 770-772-7200

ILLINOIS  
CHICAGO  
1601 FRONTENAC ROAD  
NAPERVILLE, IL 60563  
PHONE: 630-848-5100  
FAX: 630-848-5110

INDIANA  
INDIANAPOLIS  
5525 W MINNESOTA STREET  
INDIANAPOLIS, IN 46241  
PHONE: 317-246-5100  
FAX: 317-246-5110  
800-428-4141

IOWA  
DES MOINES  
1800 DIXON STREET, SUITE C  
DES MOINES, IA 50316  
PHONE: 515-263-6929  
FAX: 515-263-6515

MARYLAND  
BALTIMORE  
6880 SANTA BARBARA RD.  
SUITE 22-24  
ELKPRIDGE, MD 21075  
PHONE: 410-579-2135  
FAX: 410-579-2677

MASSACHUSETTS  
BOSTON  
6 PULLMAN STREET  
WORCESTER, MA 01606  
PHONE: 508-854-0708  
FAX: 508-854-0291

## MICHIGAN

DETROIT  
33782 STERLING PONDS BLVD  
STERLING HEIGHTS, MI 48312  
PHONE: 586-978-9800  
FAX: 586-978-9969

GRAND RAPIDS  
688 3 MILE ROAD NW  
GRAND RAPIDS, MI 49504  
PHONE: 616-785-1784  
FAX: 616-785-1788

## MINNESOTA

MINNEAPOLIS  
21080 134TH AVE. NORTH  
ROGERS, MN 56374  
PHONE: 763-428-3633  
FAX: 763-428-4551

MISSOURI  
ST LOUIS  
422 INDUSTRIAL DRIVE  
MARYLAND HEIGHTS, MO 63043  
PHONE: 314-298-1800  
FAX: 314-298-7680

KANSAS CITY  
1501 BEDFORD AVENUE  
NORTH KANSAS CITY, MO 64116  
PHONE: 816-587-0272  
FAX: 816-587-3735

## NEW YORK

AUBURN  
ONE ELLIS DRIVE  
AUBURN, NY 13021  
PHONE: 315-255-3403  
FAX: 315-253-9923

NORTH CAROLINA  
GREENSBORO  
1220 ROTHERWOOD ROAD  
GREENSBORO, NC 27406  
P O BOX 16500  
GREENSBORO, NC 27416  
PHONE: 336-272-6104  
FAX: 336-273-6628

## OHIO

CINCINNATI  
2628 CRESCENTVILLE ROAD  
WEST CHESTER, OH 45069  
PHONE: 513-771-2600  
FAX: 513-772-2219

CLEVELAND  
8929 FREEMAY DRIVE  
MACEDONIA, OH 44056  
PHONE: 330-468-4777  
FAX: 330-468-4778

## OKLAHOMA

TULSA  
2 EAST DAVES  
BIXBY, OK 74008  
PHONE: 918-366-9320  
FAX: 918-366-9338

## OREGON

PORTLAND  
20353 SW AVERY COURT  
TUALATIN, OR 97062  
PHONE: 503-691-9010  
FAX: 503-691-9012

PENNSYLVANIA  
PHILADELPHIA  
1035 THOMAS BUSCH  
MEMORIAL HIGHWAY  
PENSACOLA, NJ 08110  
PHONE: 856-661-1442  
FAX: 856-663-6363

PITTSBURGH  
6166 BERRY ROAD  
MONROEVILLE, PA 15146  
PHONE: 412-380-7244  
FAX: 412-380-7250

## TENNESSEE

MEMPHIS  
4000 WINCHESTER ROAD  
MEMPHIS, TN 38118  
PHONE: 901-365-2020  
FAX: 901-365-3914

## TEXAS

HOUSTON  
4647 PINE TIMBERS  
SUITE 1135  
HOUSTON, TX 77041  
PHONE: 713-895-7062  
FAX: 713-690-4540

DALLAS  
3040 QUEBEC  
DALLAS, TX 75247  
PHONE: 214-634-7271  
FAX: 214-634-8874

## UTAH

SALT LAKE CITY  
2230 SOUTH MAIN STREET  
SALT LAKE CITY, UT 84115  
PHONE: 801-832-0127  
FAX: 801-832-8911

## WISCONSIN

MILWAUKEE  
2725 SOUTH 163RD STREET  
NEWBERLIN, WI 53151  
PHONE: 262-784-5940  
FAX: 262-784-1215

## INTERNATIONAL SALES

FORT SMITH, AR  
P.O. BOX 2400  
FORT SMITH, AR 72902  
PHONE: 479-646-4711  
FAX: 479-648-5895

## CANADA

EDMONTON, ALBERTA  
4053-92 STREET  
EDMONTON, ALBERTA T6E 6R8  
PHONE: 780-434-4500  
FAX: 780-438-2600

OAKVILLE, ONTARIO  
2750 COVENTRY ROAD  
OAKVILLE, ONTARIO L6H 6R1  
PHONE: 905-829-3301  
FAX: 905-829-3302

MONTREAL, QUEBEC  
1844 WILLIAM STREET  
MONTREAL, QUEBEC H3J 1R5  
PHONE: 514-933-2711  
FAX: 514-933-8639

VANCOUVER,  
BRITISH COLUMBIA  
1538 KEBET WAY  
PORT COQUITLAM, BC V3C 5M5  
PHONE: 604-421-2822  
FAX: 604-421-3113

WINNIPEG, MANITOBA  
54 PRINCESS STREET  
WINNIPEG, MANITOBA R3B 1K2  
PHONE: 204-942-5205  
FAX: 204-956-4251

## AUSTRALIA

UNIT 3, 6 STANTON ROAD  
SEVEN HILLS, NSW 2147,  
AUSTRALIA  
PHONE: (61) (2) 9674 5455  
FAX: (61) (2) 9674 2495

UNIT 8, 5 KELLETTS ROAD  
ROWWILLE, VICTORIA, 3178  
AUSTRALIA  
PHONE: (61) (3) 9753 4355  
FAX: (61) (3) 9753 4366

AMERICA DEL SUR  
APTDO. 9109 0818 ZONA 6  
BETHANIA  
CIUDAD DE PANAMÁ, PANAMÁ  
PHONE: +507 261-5347  
FAX: +507 261-5355

CENTRO AMÉRICA Y CARIBE  
RESIDENCIAL PINARES DE SUIZA  
POL. 15 #44,  
NVA. SAN SALVADOR, EL SALVADOR  
PHONE: +503 2288-1519  
FAX: +503 2288-1518

## CHINA

SHANGHAI JIA-HUA BUSINESS CENTER  
ROOM NO. A-8421  
808 HONG QIAO ROAD  
SHANGHAI 200003  
PHONE: 86-21-64473600  
FAX: 86-21-64078620

## GERMANY

DIESELSTRASSE 22  
D-85551 KIRCHHEIM  
MUNICH, GERMANY  
PHONE: (49) (89) 90508 0  
FAX: (49) (89) 90508 492

## INDIA

14, COMMERCE AVENUE  
MAHAGANESH COLONY  
PAUD ROAD  
PUNE - 411 038  
MAHARASHTRA, INDIA  
PHONE: 91 20 25 45 95 30  
FAX: 91 20 5 4 95 30

## ITALY

BALDOR ASR AG  
SUCCURSIALE DI MENDRISIO  
VIA BORROMINI, 20A  
CH-6850 MENDRISIO  
SWITZERLAND  
PHONE: 41 91 640 9950  
FAX: 41 91 630 2633

## JAPAN

DIA BLDG 802,  
2-21-1 TSURUYA-CHO,  
KANAGAWA-KU  
YOKOHAMA, 221-0835, JAPAN  
PHONE: 81-45-412-4506  
FAX: 81-45-412-4507

## KOREA

ROOM 208-37  
INCHEON INDUSTRIAL GOODS  
CIRCULATING CENTER  
SONGHYEON 3-DONG, DONG-GU  
INCHEON, KOREA, 401-705  
PHONE: 82 32 588 3253  
FAX: 82 32 588 3254

## MEXICO

KM. 2.0 BLVD. AL AEROPUERTO  
LEON 3745, GUANAJUATO,  
MEXICO  
PHONE: 52 477 761 2030  
FAX: 52 477 761 2010

MIDDLE EAST & NORTH AFRICA  
VEE INTERNATIONAL CORP  
3233 NORTH ARLINGTON HEIGHTS  
SUITE 100W  
ARLINGTON HEIGHTS, IL 60004  
PHONE: 847 590 5547

## SINGAPORE

51 KAM BUKIT ROAD 2  
K B WAREHOUSE COMPLEX  
SINGAPORE 417863  
PHONE: (65) 6 744 2572  
FAX: (65) 6 747 1708

## SWITZERLAND

POSTFACH 73  
SCHUTZENSTRASSE 59  
CH-8245 FEUERTHALEN  
SWITZERLAND  
PHONE: (41) (52) 6474 700  
FAX: (41) (52) 6592394

## TAIWAN

4F, NO. 25, SEC. 1,  
TUNHUA S ROAD,  
TAIPEI 10657, TAIWAN, R.O.C.  
PHONE: (886-2) 2577-4352  
FAX: (886-2) 2577-4157

## UNITED KINGDOM

6 BRISTOL DISTRIBUTION PARK  
HAWKLEY DRIVE  
BRISTOL BS52 2BF, U.K.  
PHONE: +44 1454 859000  
FAX: +44 1454 8590019





★ 1 2 4 0 - 0 6 0 6 ★

**BALDOR®**

**BALDOR ELECTRIC COMPANY**  
**5711 R.S. Boreham Jr. Street**  
**Fort Smith, AR 72901-2400**  
**(479) 646-4711**  
**Fax (479) 648-5792**