

ACCU ELECTRIC MOTORS INC

USA: (888) 932-9183

CANADA: (905) 829-2505

- ✓ Over 100 years cumulative experience
- ✓ 24 hour rush turnaround / technical support service
- ✓ Established in 1993



The leading independent repairer of servo motors and drives in North America.

Visit us on the web:

www.servo-repair.com

www.servorepair.ca

www.ferrocontrol.com

www.sandvikrepair.com

www.accuelectric.com

Scroll down to view your document!

For 24/7 repair services :

USA: 1 (888) 932 - 9183

Canada: 1 (905) 829 -2505

Emergency After hours: 1 (416) 624 0386

Servicing USA and Canada

1. INTRODUCTION TO THE PARAMETER UNIT

The FR-PU01E parameter unit is installed to the FR-Z series inverter or connected to it by a cable (option) and allows operation to be performed, functions to be selected (set values to be read/written), the operating status to be monitored, and alarm function to be displayed.

The FR-P01E parameter unit is hereinamter referred to as the "PU."

Display:

7-segment display (4 digits) for indicating the frequency, motor current, functiou set value, alarm definition, etc.

Installation screw:

Loosen the two screws to remove the PU from the inverter.

Monitoring mode indicator lamps:

Indicate the units of data currently being displayed (e.g. frequency, motor current).

Select mode indicator lamps:

When any of the mode select keys are pressed, the corresponding lamps are lit to indicate the mode selected.

Mode select keys:

Used to select operation by PU, operation by external signals, write/read of function set values, or monitoring of frequency, motor current, alarm display.

Frequency change keys:

Used to continuously increase or decrease the running frequency. Only valid while pressed.

Operation command keys:

Give forward, reverse and stop commands.

Write, read keys:

Used to check (read) and change (write) function set values after pressing the **SET** key.

Function and numeral keys:

Used to select any of the first functions and enter the frequency, functiou number and set value.

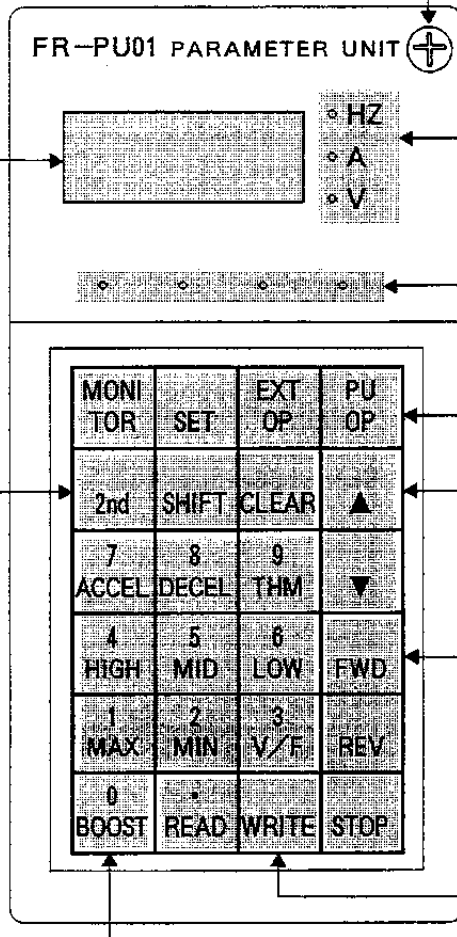

Second, third function select (2nd) key:

Used to read and change (write) the set value of any secoud function after pressing the **SET** key. Used with the **SHIFT** key to select any of the third functions.

Shift key:

Used to select monitoring mode (frequency, motor current, alarm definition) or any of the third functions.

Clear key:

Used to clear a wrong set value and return to the previous value.

2. INSTALLATION OF THE PARAMETER UNIT

The PU may either be installed directly to the inverter or connected to the inverter by an optional cable so that it may be hand-held or installed in a panel. The PU may be installed and removed when the inverter is on or running.

2.1 Direct Installation to the Inverter

The PU is used on the front cover of the inverter (electrically coupled by the connector). For the modes not equipped with the PU, remove the accessory cover from the inverter front cover and install the PU in that position.

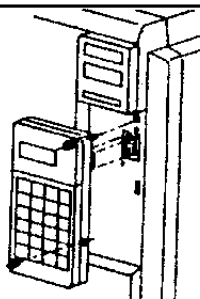

(1) Connection

Securely insert the PU connector into the inverter connector as shown on the left.

(2) Fixture

Securely fix the PU to the inverter with two PU installation screws.

CAUTION

The PU should be installed directly to the inverter with the inverter front cover installed.

2.2 Connection Using the Cable

The PU may be installed not only to the inverter but also to the surface of a panel or may be hand-held for adjustment, maintenance, inspection, etc. In this case, an optional cable is required for connection of the PU to the inverter.

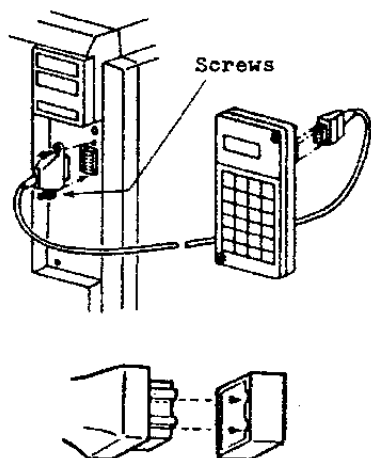

(1) Connection

Securely insert one end of the cable into the inverter connector and the other end into the PU as shown on the left.

Insert the cable plugs along the connector guides (as shown on the left).

(The inverter may be damaged if the plug is inserted in the wrong direction.)

(2) Fixture

Secure the inverter-side cable plug with installation screws.





Fix the PU-side cable plug so that the cable may not be disconnected by its own weight.

CAUTION

The cable (option) for use with the PU must only be used to connect the PU and inverter.

3. FUNCTIONS OF THE PARAMETER UNIT

The PU may be used in a wide variety of applications from motor operation to monitoring as described below:

<p>Selection of operation mode (p.37)</p>	<p>Allows selection between external operation mode and PU operation mode.</p> <p>External operation.....The inverter is operated using from the start switch and frequency setting variable resistor, connected to the inverter terminal block.</p> <div style="text-align: center;">  </div> <p>PU operation.....The inverter is started/stopped and set to running frequency from the PU keyboard.</p> <div style="text-align: center;">  </div>
<p>Operation of motor (p.38)</p>	<p>The frequency may either be entered directly from the ten-key pad or by holding down the  (or ) keys.</p>
<p>Change of function set value (p.39)</p>	<p>Allows the required function to be read directly or rewritten.....p. 40</p> <p>Convenient functions</p> <ul style="list-style-type: none"> ●All set value clear (initialization)p. 43 ●Write disable p.56 ●Frequency meter calibration.....p. 42
<p>Monitoring (p.44)</p>	<p>Allows the operating status (e. g. output frequency, motor current) to be checked and alarm definitions to be monitored.</p>

Operation Mode

There are two major operation modes for the inverter; “operation by external input signals” and “operation by PU.” The operation mode may either be selected (switched) by PU’s mode select keys or limited (fixed) as specified.

Factory-Set Operation Mode (Default on Inverter Power Up)

The operation mode defaults to “external input signal operation” mode. Hence, the inverter is ready to be operated by powering it up. In this state, switch on the start signal (across STF/STR and SD) to start operation.

Limiting (Fixing) the Operation Mode

The operation mode at power on may be limited, e. g. operation from the PU is enabled at power on without switching the operation mode with the PU’s mode select key. For full information on setting the operation mode, see page 56.

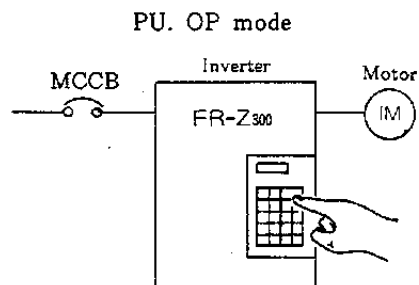
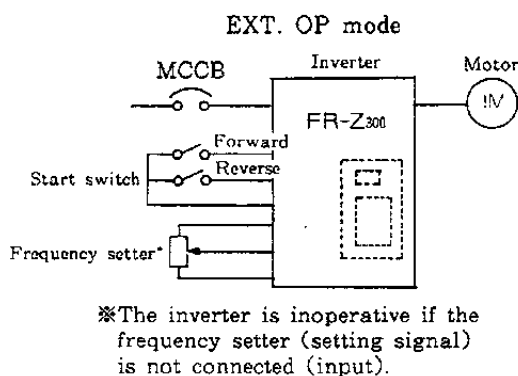
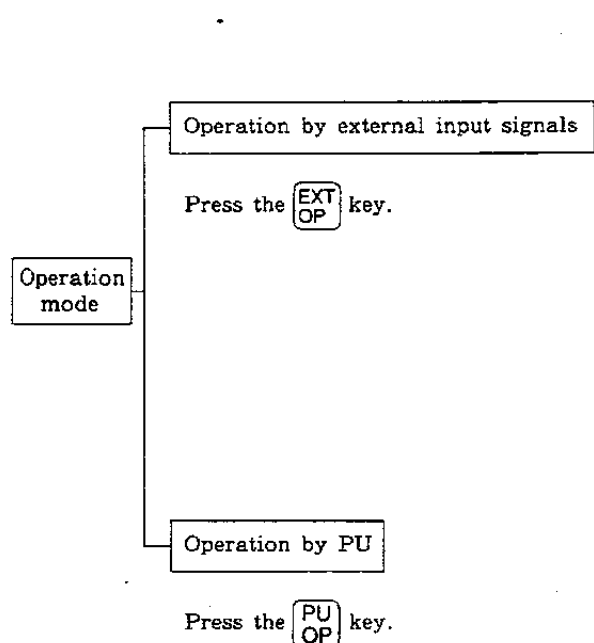

Note Switching from PU operation mode to external input signal operation mode
This switching cannot be performed if the start signal is on (across terminals STF/STR and SD). The switching operation must be performed (the  key pressed) after the start signal has been switched off and the motor has stopped.

The motor can be started and stopped from the PU without using the external frequency setter or start switch. The PU also allows jog operation.

Operating Procedure

Key press procedure examples

(1) Directly entering (setting) the required frequency <<Direct setting>>

Key press sequence

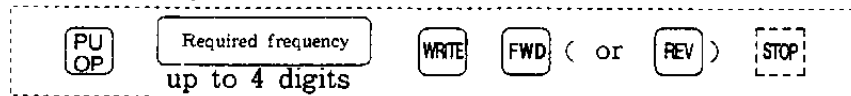



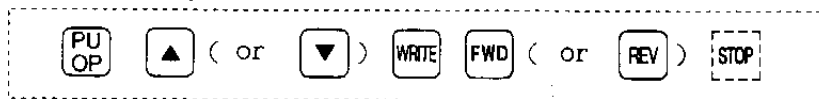

Setting the running frequency Repeating this setting during operation allows the speed to be varied.

(2) Setting the required frequency with gradual speed change with or key <<Step setting>>

Key press sequence



Use the  or  key to define the required frequency. The frequency only increases (or decreases) while the  or  key is pressed.



These keys may also be used for microadjustment as the frequency change is slow at first, gradually increasing with time as key is pressed.

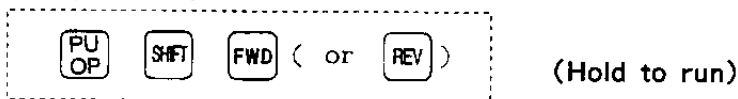

Note When the required frequency has been defined, the  key must be pressed to store the set frequency.

(3) Jog operation

Key press sequence



Hold down the  (or ) key to operate, release to stop. The jog operation frequency is the value set in parameter 15.

To return to external operation mode, press the  key and after the motor has stopped, press the  key. (If switching is not achieved, see page 43.)

(4) Changing the speed from the PU during multi-speed operation

See the procedure (1) or (2) on page 33.

Typical Operation

● 60Hz operation (Stop to 60Hz)

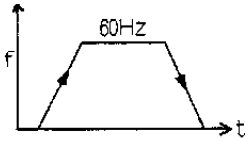

	60Hz Setting	Start	Stop
Key used	PU OP 5 0	FWD or REV	STOP
indication	<div style="display: flex; align-items: center;"> <div style="border: 1px solid black; padding: 2px; margin-right: 5px;">60</div> <div style="margin-left: 5px;"> * Hz ○ A ○ V ○ * </div> </div> <div style="display: flex; align-items: center;"> <div style="border: 1px solid black; padding: 2px; margin-right: 5px;">F</div> <div style="margin-left: 5px;"> alternately </div> </div>	<div style="display: flex; align-items: center;"> <div style="border: 1px solid black; padding: 2px; margin-right: 5px;">6000</div> <div style="margin-left: 5px;"> * Hz ○ A ○ V </div> </div> <div style="display: flex; align-items: center;"> <div style="border: 1px solid black; padding: 2px; margin-right: 5px;">*</div> <div style="border: 1px solid black; padding: 2px; margin-right: 5px;">○</div> <div style="border: 1px solid black; padding: 2px; margin-right: 5px;">○</div> <div style="border: 1px solid black; padding: 2px; margin-right: 5px;">*</div> </div>	<div style="display: flex; align-items: center;"> <div style="border: 1px solid black; padding: 2px; margin-right: 5px;">0000</div> <div style="margin-left: 5px;"> ○ Hz ○ A ○ V </div> </div>

● Speed change during operation (60Hz to 30Hz)

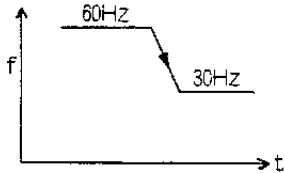

	(60Hz Operation)		30Hz Setting
Key used	—	PU OP	3 0 WTE
indication	<div style="display: flex; align-items: center;"> <div style="border: 1px solid black; padding: 2px; margin-right: 5px;">6000</div> <div style="margin-left: 5px;"> ● Hz ○ A ○ V </div> </div>	<div style="display: flex; align-items: center;"> <div style="border: 1px solid black; padding: 2px; margin-right: 5px;">6000</div> <div style="margin-left: 5px;"> alternately </div> </div>	<div style="display: flex; align-items: center;"> <div style="border: 1px solid black; padding: 2px; margin-right: 5px;">30</div> <div style="margin-left: 5px;"> * Hz ○ A ○ V </div> </div> <div style="display: flex; align-items: center;"> <div style="border: 1px solid black; padding: 2px; margin-right: 5px;">F</div> <div style="margin-left: 5px;"> Displayed alternately </div> </div>

Note When the monitoring mode indicator lamp is on, direct frequency setting cannot be performed. In this case, set the frequency again after canceling monitoring mode by pressing the **PU** key.

● Jog operation

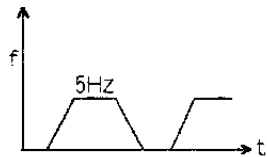

	Selecting jog Mode	Operation
Key used	PU OP SWT	FWD (or REV)
indication	<div style="display: flex; align-items: center;"> <div style="border: 1px solid black; padding: 2px; margin-right: 5px;">JOG</div> <div style="margin-left: 5px;"> ○ Hz ○ A ○ V ○ * </div> </div>	<div style="display: flex; align-items: center;"> <div style="border: 1px solid black; padding: 2px; margin-right: 5px;">* 5.00</div> <div style="margin-left: 5px;"> * Hz ○ A ○ V * </div> </div>

Note

- JOG mode cannot be selected during motor operation and must be selected after stopping the motor by the **STOP** key.
- Press the **PU OP** key to cancel JOG mode.
- The jog operation frequency and acceleration/deceleration time (acceleration time = deceleration time) can be defined by parameters. (See page 53.) Their factory-set values are 5Hz and 0.5 seconds (i.e. acceleration/deceleration takes 0.04 seconds to reach 5Hz.)
- Check the starting frequency if the motor does not start. **Pr 13**
If start frequency **Pr 13** is higher than Jog frequency **Pr 15**, motor will not start.

● Monitoring mode is automatically selected and the current output frequency displayed when the motor is started by pressing the start key (**FWD** or **REV**).*

● The mode indicator lamp above the **PU OP** key flickers to indicate that the inverter is running (motor is rotating). (This also applies to the DC injection brake operation.)

Changing or Checking the Function Set Values

The PU allows the required function to be selected from among many functions of the inverter and their set values can be changed or checked.

The factory-set value need not be changed when they are appropriate.

Function groups 1 to 3 are different in operating procedure as described below.

Operating Procedure

(1) Setting the first function (numbers 0 so 9) Main function

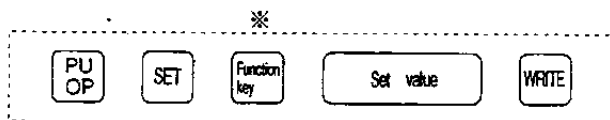

Note: The procedure on the left allows speed change to be made during three-speed operation (high, medium, low).

※The function names (abbreviated) are indicated on the keys (0 to 9).

(2) Setting the second function (from function number 10 onward) Used for application operation, etc.



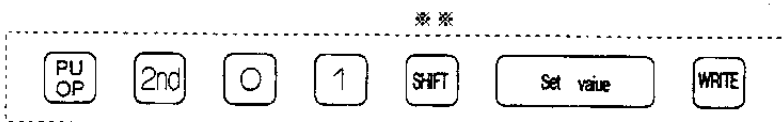

Note: The procedure on the left allows speed change to be made during multi-speed operation (speeds 4 to 7).

(3) Setting the third function Calibration



※※ The required function is called and set in accordance with the number of times the  key is pressed. For more information, see page 48.

Reading the set value

In any of the above procedures, do not enter the set value and press the  key instead of .

(Example)     (Second function)

Terminating or canceling the function setting

Press the  key to switch to monitoring or motor operation from the PU during setting or on completion of write.

Setting Examples

- (1) **Setting the first function (acceleration time)** Change from 5 seconds to 10 seconds.

	Selecting First Function	Setting Acceleration Time	Reading Present Value	Changing to 10 Seconds	Write
key used					
Indication					 ↑ Displayed alternately

Note: After write is complete, any function number of the first functions may be called by pressing the corresponding function key without pressing .

- (2) **Setting the second function (jog operation frequency)** Change from 5Hz to 10Hz.

	Selecting Second Function	Setting Jog Frequency	Reading Present Value	Changing 10Hz	Write
key used					
Indication			 (5Hz)	 (10Hz)	 ↑ Displayed alternately

- Note: 1. **Pr.** is followed by a period to indicate that the function selected is the second function. (**Pr.**)
2. After write is complete, any parameter number of the second functions may be called by pressing and entering the corresponding without pressing .

When the required function cannot be changed or read

See page 42 if the setting procedure result in alarm display and the set value cannot be written.

Calibrating the Frequency Meter

The PU allows calibration (adjustment) of the display meter connected across the frequency meter connection terminals FM and SD of the inverter.

When a digital display meter is used, the PU allows the frequency of the pulse train output signal to be adjusted.

- Preparation:**
- (1) Connect a frequency meter across inverter terminals FM and SD.
(Note the polarity.)
 - (2) When a calibration resistor has already been connected, adjust the resistance value to zero or remove the resistor.

Operating Procedure

1. Set the reference output frequency of the FM terminal.

it need not be set when operation is performed at the maximum output frequency of 60Hz or less.

PU OP READ 2nd 3 8 Set value WRITE

↑ Set max frequency

Default value is 60Hz
2. Perform operation at the maximum output frequency from the PU. (*)

PU OP Set value WRITE FWD (or REV)

PU OP 2nd 0 1
3. Select the meter calibration mode.
4. Adjust the reading.

Hold down the ▲ (or ▼) key in accordance with the meter reading.

Press the WRITE key on completion of adjustment.

※The motor need not be connected.

Typical Operation Operation at the maximum output frequency of 120Hz

Step	Keying Sequence
1 Set 120(Hz) in function 20 "frequency at 5V input."	PU OP SET 2nd 2 0 1 2 0 WRITE
2 Set 120(Hz) in function 38 "FM terminal reference output frequency."	PU OP SET 2nd 3 8 1 2 0 WRITE
3 Operate at 120Hz from the PU.	PU OP 1 2 0 WRITE FWD (or REV)
4 Select calibration mode.	PU OP 2nd 0 1
5 Make calibration.*	Adjust with ▲ or ▼ key and press WRITE key on completion.
6 Check linearity. (Run at 60Hz.)	PU OP 6 0 WRITE (Check that the reading is 60Hz)
7 Stop operation.	STOP

Note*: Calibration cannot be made if the parameter write disable has been set (set value of function 77 is 1).

Initializing the Set Values

All or most of the function settings can be returned to the factory-set values (initialized). This operation is referred to as "all clear."

Either of the following all clear types may be selected.

All Clear Types

Either type may be selected by function 75:

All Clear Mode	Set Value of Function	Initialization
Initialization with the exception of some functions	0 (Factory setting)	All functions are initialized with the exception of the frequency at 5V input, frequency at 20mA input, parameter write disable selection, frequency setting voltage and current bias/gain (third functions).
Initialization of all functions*	1	All functions are initialized to factory-set values.

*All clear mode (function 75) is also initialized to the factory-set value.

Operating Procedure Initialization in all clear mode selected by function 75

PU
OP SET 2nd 8 •
READ 9 •
READ WRITE

On completion of write, R L L E is displayed and flickers.

The PU allows monitoring (on the segment display and LEDs) of the inverter output status (e. g. output frequency, output voltage), load state (e. g. motor current) and activated protective function at alarm occurrence.

Types of Monitoring

Monitoring Type		Unit	Display	Remarks
Output frequency		Hz	Display and monitoring mode indicator lamps	In monitoring mode, press SHIFT to switch the data being displayed. (p. 38)
Output voltage		V		
Motor current	Steady- state	A		
	Peak	A		
Regenerative brake operation factor		%		
Converter output voltage		V		
Speed		rpm, etc.	Switched from output frequency being monitored when function 37 is set. (p. 53)	
Direction of rotation		—	Monitoring mode indicator lamps	Forward ... on. reverse ... flicker.
Running		—	Select mode indicator lamps	The lamp above the corresponding mode select key is lit. Flickers during run and lit during stop.
External/PU operation mode		—		
Monitoring mode		—		
Setting mode		—		
Jog mode		—	Display	"Jog" is displayed when jog operation mode is selected. (p. 31)
Alarm definition*	Protection name	(Symbol)		Indicates the protective function activated. Allows past alarms to be checked. (p. 38)
	Code	(Numeral)		Valid only when function 76 has been set. (p. 53)
Current limiting operation		—	Monitoring mode indicator lamps	All monitoring mode indicator lamps are lit when the limiting function is activated.

* For alarm definitions, see page 40.

Display (4-digit, 7-segment LED)

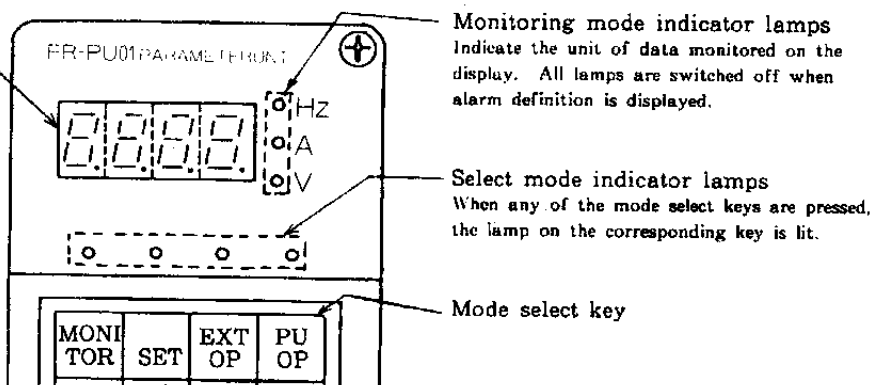

Parameter unit

Typical Operation

- Output frequency, motor current (steady-state), output voltage, alarm definition (check)

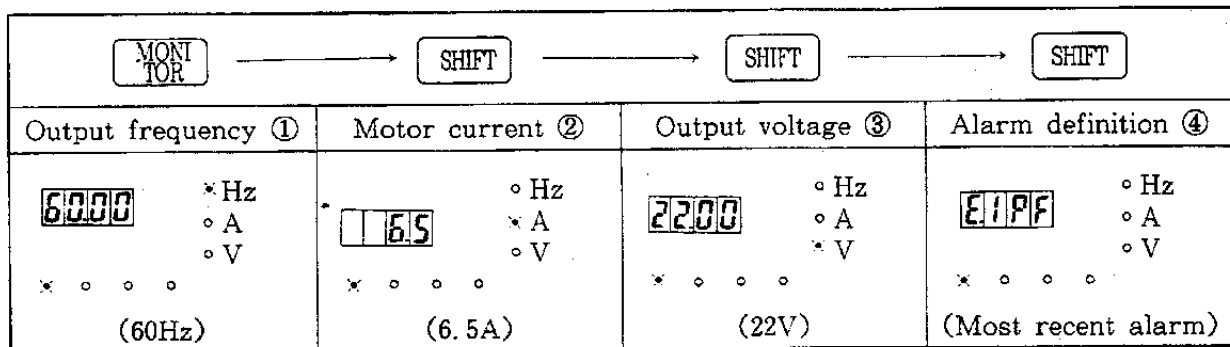

Note: When the alarm definition^④ is being displayed, press **SHIFT** one more time to return to the output frequency display.①

● To read the past alarm definitions

Up to four alarm definitions can be read, beginning with the most recent alarm.

Perform the following operation when the most recent alarm definition is being displayed as indicated above.

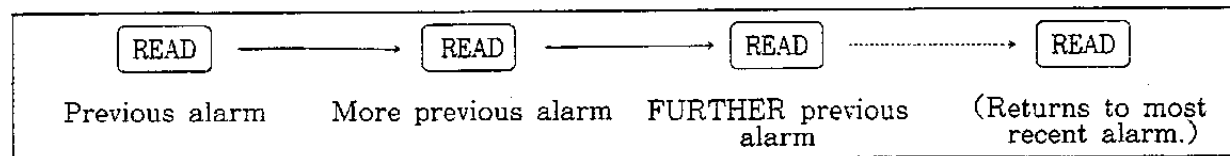

Note 1. To clear the alarm definitions :

When the alarm definition is being displayed, press the **CLEAR** key to clear the alarm definition currently being displayed from the memory and display the preceding alarm definition. (Note)

2. To read the operating status immediately before alarm occurrence :

On occurrence of alarm, the display automatically switches to the indication of the protective function activated. At this time, press the **SHIFT** key (without resetting) to return to the output frequency monitoring. This allows the running frequency immediately before alarm to be read. This also applies to the current and voltage values which, however, do not remain in memory.

3. Repeated alarm errors will cause the inverter, to "drop off" the oldest error in memory.

● Motor peak current, regenerative brake operating factor, converter output voltage, alarm code

Any of the above data may be selected by setting the function 76.

The selected data is displayed for the above output voltage monitoring.

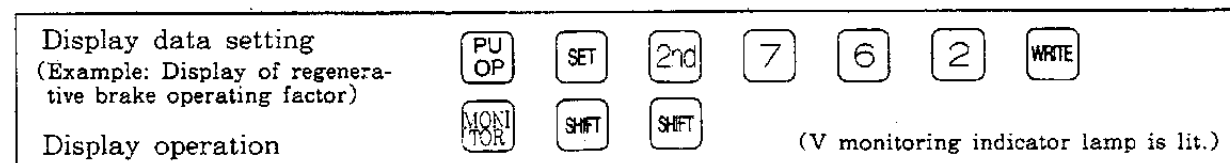

(Note) : Never clear the alarm history record, if you are going to call out a Mitsubishi service engineer. The service history alarm will assist in deciding the reason for the inverter tripping. If no alarm history is present, for the service engineer to check, then there was no need to call out an engineer.

● To read the speed

Any of the motor and load shaft speeds, line speed, etc. can be displayed in proportion to the output frequency.

The speed display is made valid when other than 0 is set in function 37.

To display the speed of a 4-pole motor :

Function setting

PU
OP

SET

2nd

3

7

4

WRITE

(4 poles)

Display

Running the inverter switches the output frequency (Hz) monitoring to the speed display in R.P.M (equivalent to frequency).

- Note :
1. For full information on the function set values, see page 60.
 2. The displayed speed is not the actual speed. Use the "FR-ZPO feedback control" option to display the actual speed.
 3. The display switches to the speed by reading any of the frequency set value, such as the running or set frequency defined by the PU (see page 51).

Example : When the running frequency has been set to 30Hz from the PU, reading the speed as indicated above displays 900 (rpm).

$$\text{Displayed speed } N = \frac{120 \times f \text{ (running frequency)}}{p \text{ (number of poles)}}$$

Monitoring Mode Indicator Lamps

In this manual, the monitoring mode indicator lamps are indicated in the following arrangement. ● indicates that any of the monitoring mode and select mode indicator lamps is on and ○ indicates off.

Indication	Function	
○ Hz	Indicates the frequency. (Note 1)	All lamps except for the selected mode flicker if the current limiting or stall prevention function is switched on in monitoring mode. On during forward run and flicker during reverse run.
○ A	Indicates the motor current.	
○ V	Indicates the output voltage. (Note 2)	

- Note :
1. The speed is displayed when other than 0 is set in function 37.
 2. Other data is displayed when any of 1 to 4 is set in function 76. (See page 60)